



La storia dei Sistemi Operativi

Stefano Borzi

Primo programmatore?

Ada Lovelace

Matematica britannica - 1800



1945-1955 valvole termoioniche



anni '50-'60



Transistor

```
helloworld.f + (~) - VIM
program helloworld
implicit none
character*13 hello_string
hello_string = "Hello, world!"
write (*,*) hello_string
end program helloworld
```

FORTRAN

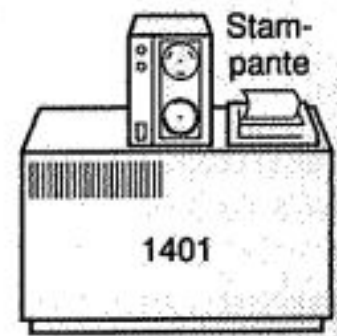
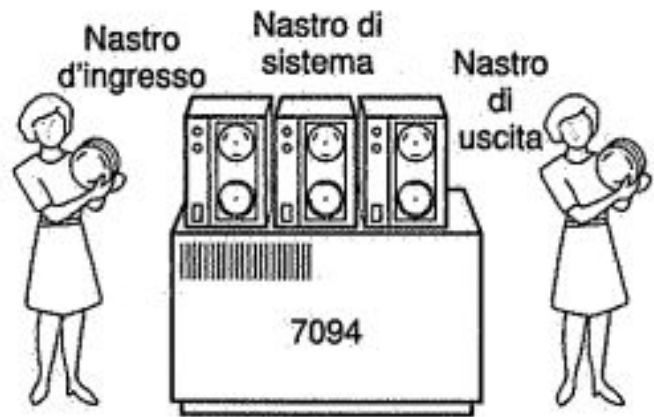

1965 - 1980

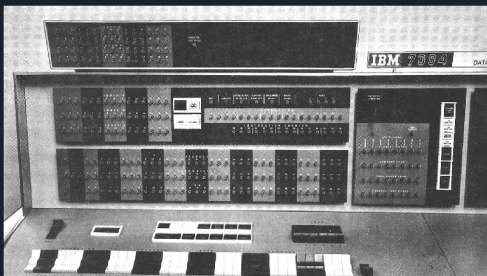

IBM 7094

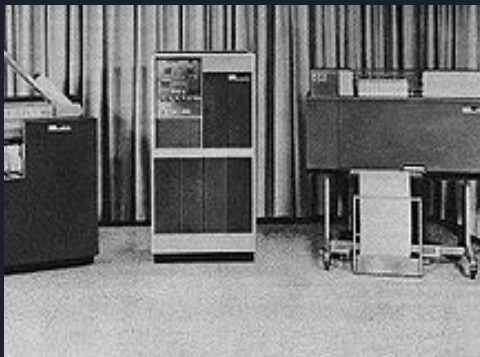

IBM 1401



IBM System/360 (1964)

Time-sharing

CTSS

MULTICS

PDP-1

1965 - 1980



Ken Thompson con Dennis Ritchie



UNIX e derivate

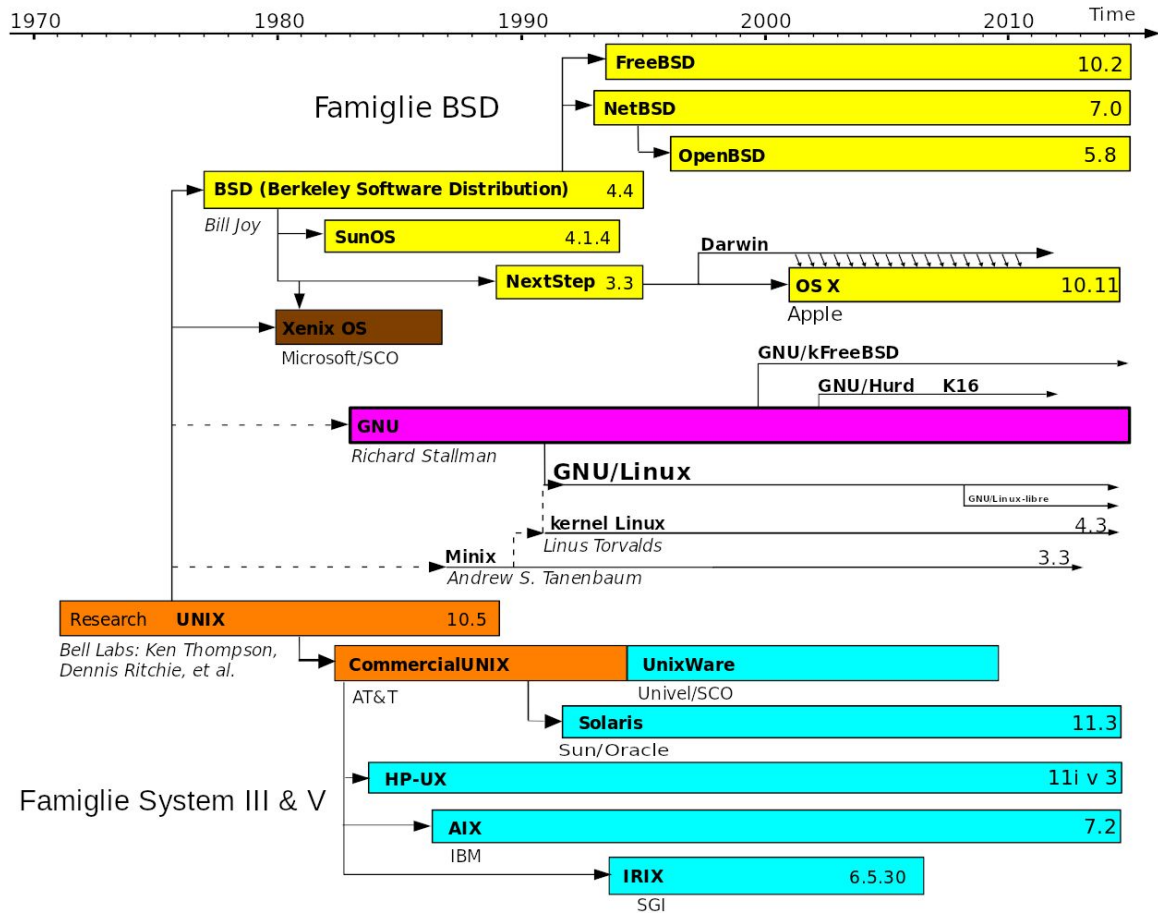



1800



1945



1950



1965



1969

Personal Computer (1976)



Steve Jobs



Steve Wozniak



1976



1984 - Mac OS



1975



Bill Gates



**Steve Ballmer
(2008)**



**Satya Nadella
(2014)**



VS



1983

1991

1997

2007



BSD



OS X



UNIX e derivate

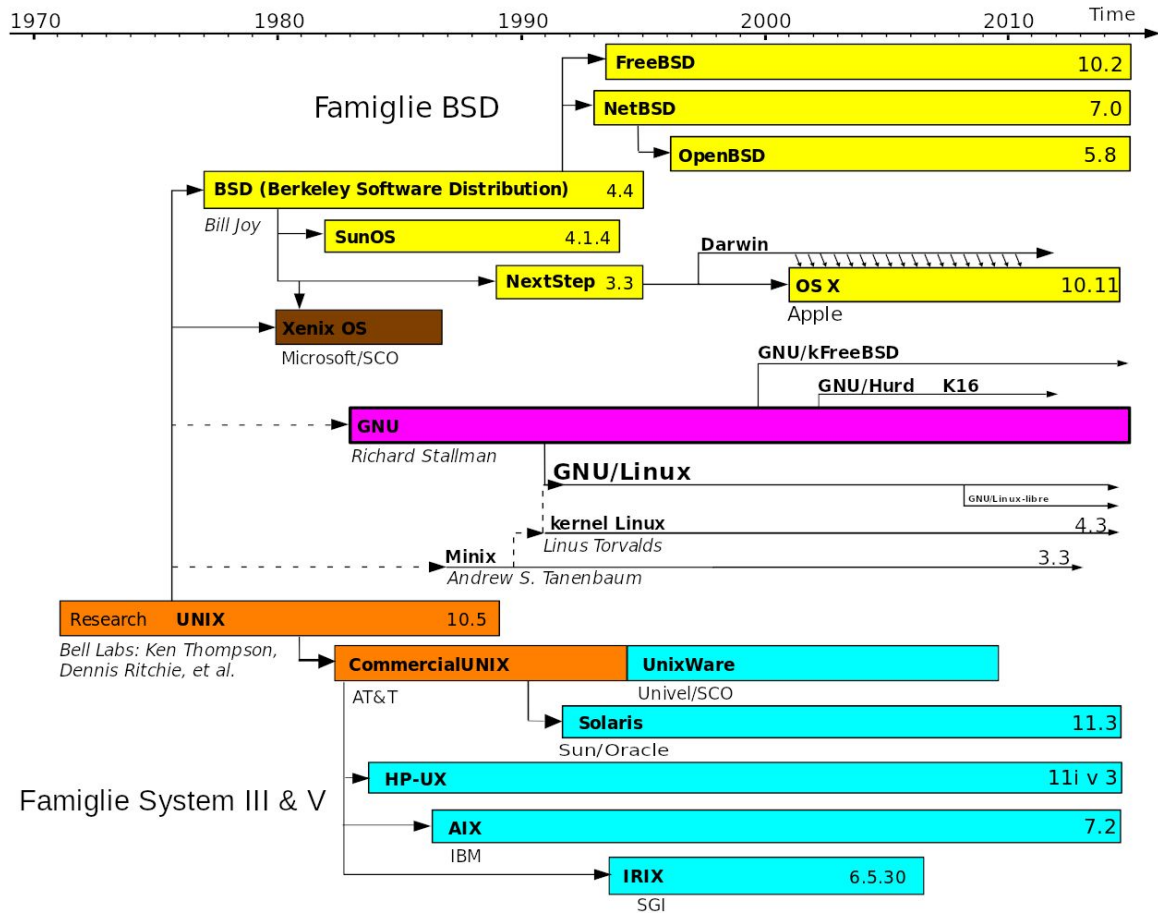

GNU Linux



Richard Stallman



Linus Torvalds

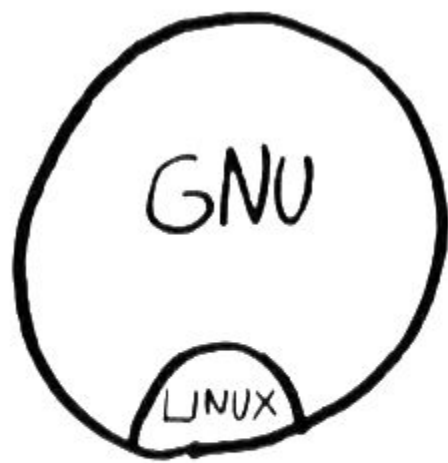
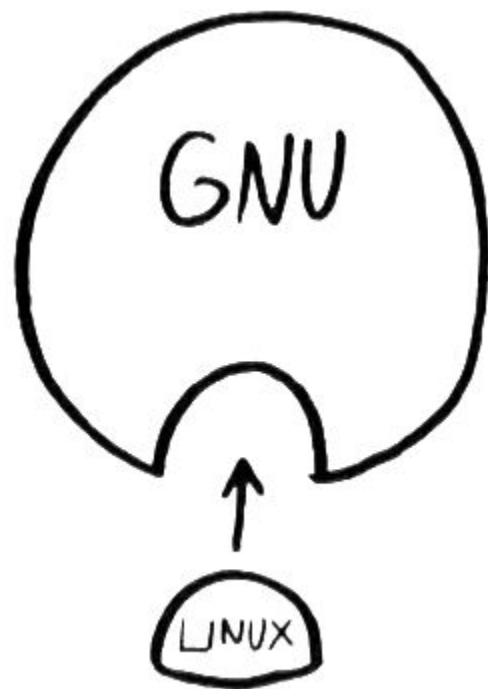

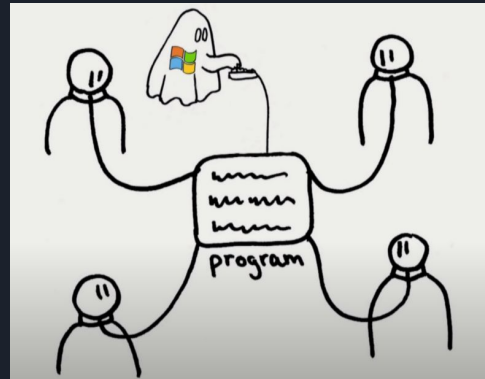
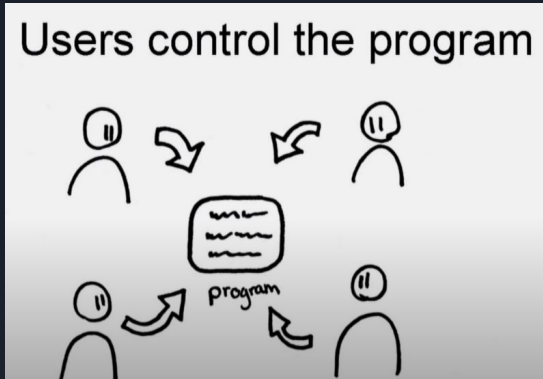
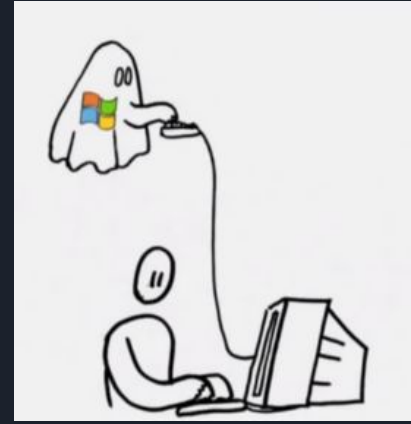
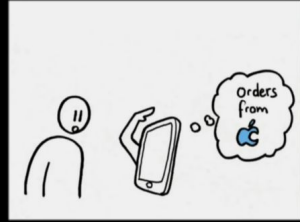



1985

Hacker News

Lenovo liable for 20000€ in damages for refusing a 42€ Windows refund

[Article](#), [Comments](#)

FSFE - Free Software Foundation Europe

Refund of pre-installed Windows: Lenovo must pay 20,000 euros in damages - FSFE

In a historic judgment in Italy, in a case initiated by FSFE supporter Luca Bonissi, Lenovo was ordered to pay 20,000 euros in damage...



02-03-2021

Linus Torvalds insulta Nvidia per il supporto

"Nvidia: Fuck you" e un ditto
epiteto molto chiaro
vista, la situa
operat

a usato un
nunto di
a

**Linus Torvalds: "HFS+ è
certamente il peggiore
filesystem mai creato".**

guru. Torvalds ha
regola e si è anche detto
abilità, prendendo spunto da una
Optimus, che permette l'uso del core
secondo il carico di lavoro.



torvalds/linux





2005



2017



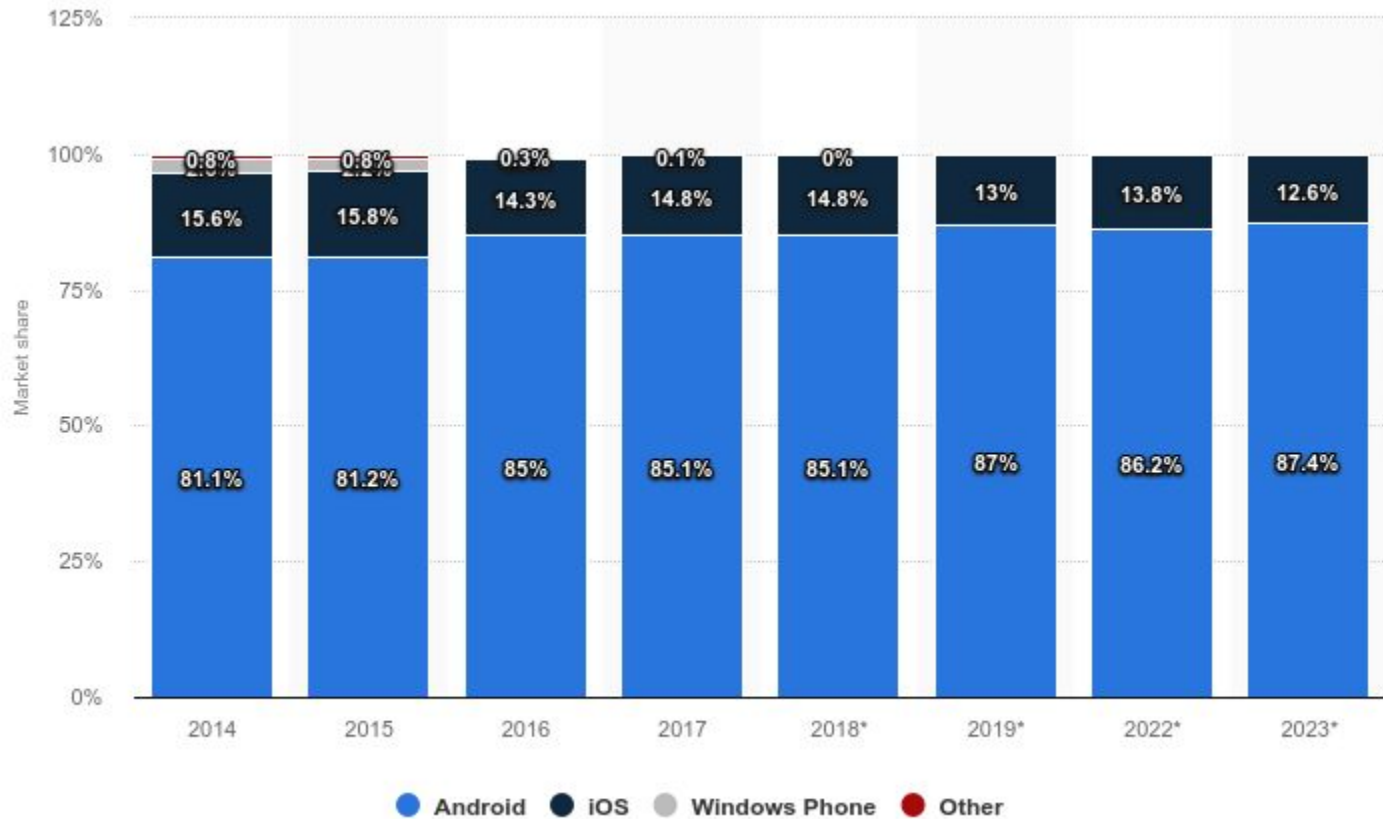

(2019)

Dov'è usato Linux?





**Steve Ballmer
(2008)**



ancer!



Iphone

MakeAGIF.com

Embrace, extend, and extinguish (EEE)



THE HALLOWEEN DOCUMENTS

1998 – Microsoft Corporation compelled to admit the authenticity of some Confidential memoranda about the suppression of Open Source Systems.

Facts, consequences and main events about the documents which put Microsoft in a big pickle at the end of 90's.

Microsoft: we were wrong about open source

Microsoft has embraced open source and even Linux in recent years

By Tom Warren | @tomwarren | May 18, 2020, 8:26am EDT



Listen to this article



SHARE

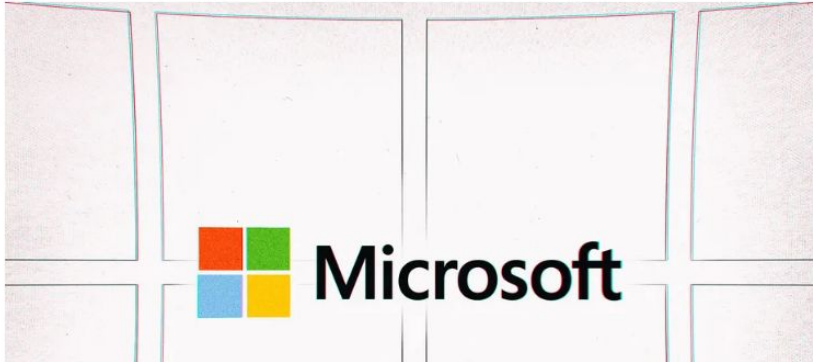

Fudzilla



Sorry Steve, Open Source beat you



**Satya Nadella
(2014)**





stonks



Fonte foto: [Shutterstock](#)

TECH NEWS



Microsoft apre all'open source ed entra nella Linux Foundation

Passo significativo per Microsoft che diventa Platinum member e sborsando 500

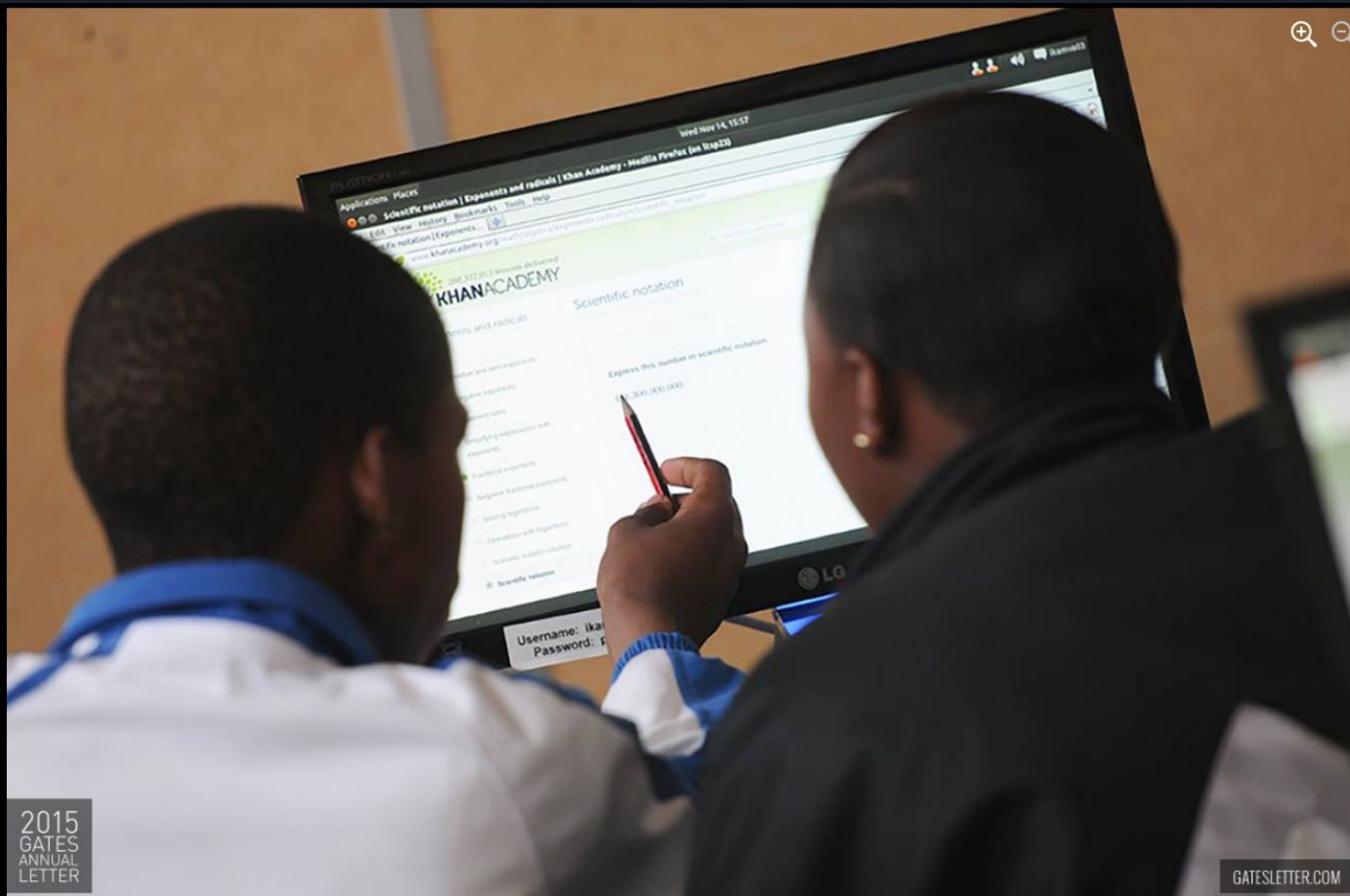

2015
GATES
ANNUAL
LETTER

GATESLETTER.COM

 **Bill Gates**
29 gennaio 2015 · 🌐

15 years from now, most people in poor countries will be able to take classes online: <http://b-gates.es/1LiNsLE>

👍🤔😬 42 Commenti: 1425 Condivisioni: 2416

👍 **Mi piace** 💬 **Commenta** ➦ **Condividi** 🌐

Più pertinenti ▼

 **Pemuja Paha Hutao**
Bill gate : 15 years again most people will be able to take clases online (2015).
Corona : thats to long bill, i can make it NOW!!! (march 2020). 😊
see, now everyone able to take clases online more faster
People : 🤔🤔🤔🤔

Mi piace · Rispondi · 9 sett. · Modificato 🗨️ 2

 **Iqbal Fabriansyah**
Power of LINUX!!
The Future for Linux

Mi piace · Rispondi · 9 sett.

 **Wahid**
speedrun 10 years

Mi piace · Rispondi · 9 sett.

 **Kevin ID**
Now all of contries take online class, because corona pandemic

Mi piace · Rispondi · 9 sett.

 **Muhammad Rayhan Maulana**
Well apparently it took only 5 years

Scrivi un commento... 🗨️ 🗨️ 🗨️



1975



1976

Personal
Computer



1984



1985





Technology News / News-Analysis

VALVE SAYS LEFT 4 DEAD 2 RUNS FASTER ON LINUX THAN ON WINDOWS



Valve had announced last month that it is working on porting its popular digital distribution platform for games, Steam, to Linux. The company was also...



SHUNAL DOKE

AUG 03, 2012 11:04:55 IST

Gabe

STEAM

Steam machine

PAUSA

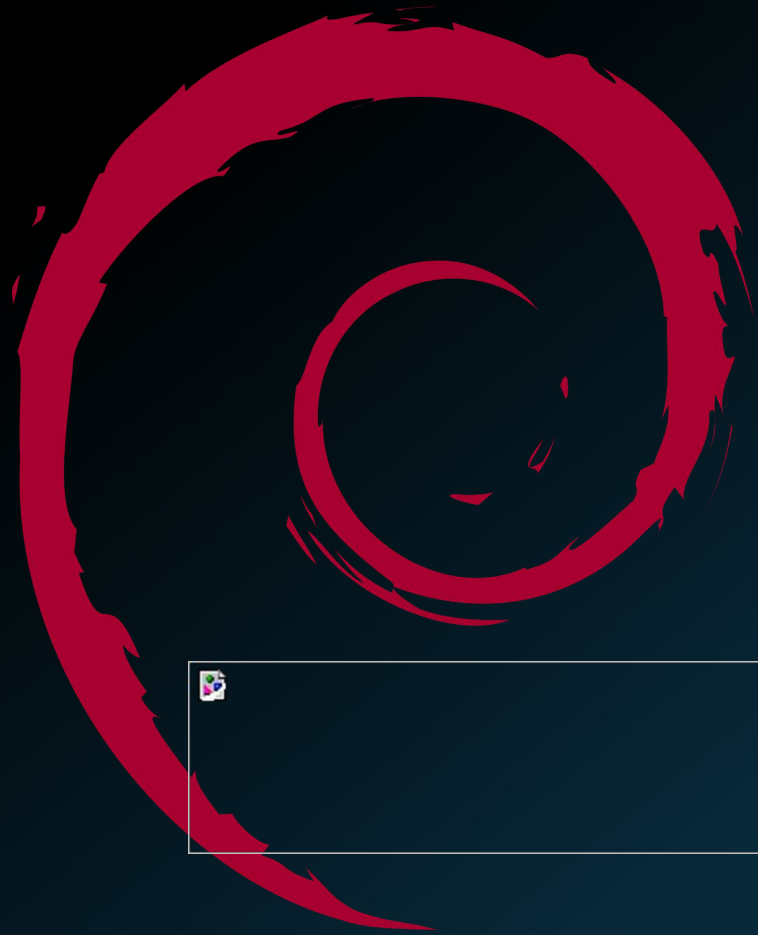

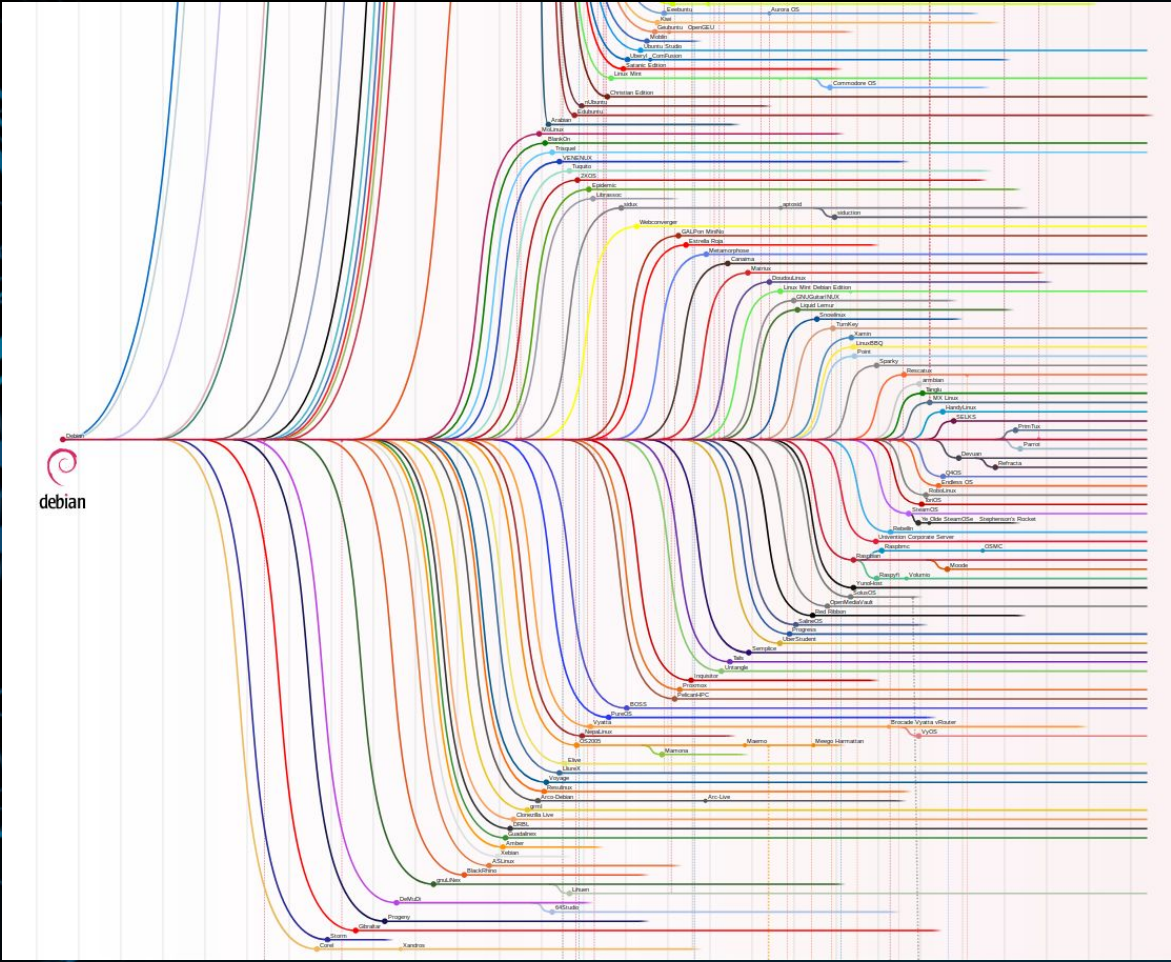





- Tipo: [Linux](#)
- Basata su: Independent
- Provenienza: [Global](#)
- Architetture: [aarch64](#), [armel](#), [armhf](#), [i686](#), [mips](#), [mipsel](#), [ppc64el](#), [s390x](#), [x86_64](#)
- Desktop: [AfterStep](#), [Awesome](#), [Blackbox](#), [Cinnamon](#), [Fluxbox](#), [flwm](#), [FVWM](#), [GNOME](#), [i3](#), [IceWM](#), [ion](#), [JWM](#), [KDE](#), [LXDE](#), [LXQt](#), [MATE](#), [Openbox](#), [pekwm](#), [Ratpoison](#), [WMaker](#), [XBMC](#), [Xfce](#)
- Categoria: [Desktop](#), [Live Medium](#), [Server](#)
- Stato: [Attiva](#)
- Popolarità: [4 \(1,560 visite al giorno\)](#)

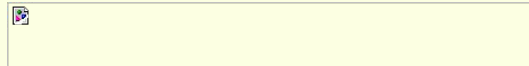



PRO

- ☒ È molto rigido per i software opensource
- ☒ Ha una grande community
- ☒ Supporta la maggior parte delle architetture di qualsiasi distribuzione binaria di Linux.
- ☒ Il formato dei suoi pacchetti “.deb” è uno dei più diffusi
- ☒ È la distribuzione Linux più vecchia e supportata dopo Slackware
- ☒ Sono sempre supportate le seguenti branch di Debian:
 - oldstable
 - stable
 - testing
 - unstable

CONTRO

- ☒ È molto rigido per i software opensource
- ☒ Usa “systemd”

Ian Murdock



Il 28 dicembre 2015 è stato trovato morto a [San Francisco](#), dove lavorava a [Docker](#). Il giorno prima era stato arrestato per violenza e resistenza a pubblico ufficiale e scarcerato dietro cauzione.^[1] Gli ultimi suoi posts su [twitter](#) denunciano ripetute violenze e umiliazioni, anche sessuali, subite durante la detenzione e proseguite fin dopo il rilascio. Ad una prima intenzione di suicidio espressa sul [social network](#), seguiva un'affermazione della volontà di combattere nel futuro contro l'abuso di potere esercitato dai dipartimenti di polizia americani.

Gli accertamenti medici successivi hanno stabilito che si trattò di [suicidio](#).^[2]





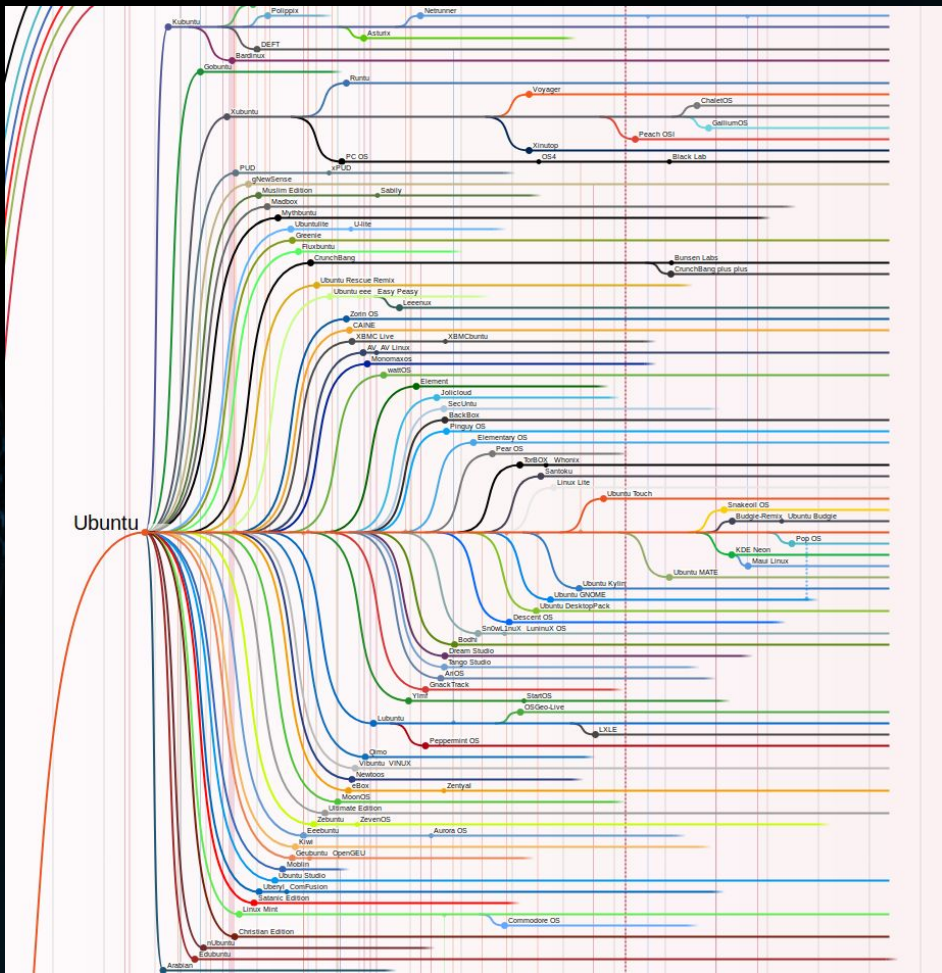



ubuntu



Trash

Install Ubuntu
19.10

ubuntu

- Tipo: [Linux](#)
- Basata su: [Debian](#)
- Provenienza: [Isle of Man](#)
- Architetture: [armhf](#), [i686](#), [powerpc](#), [ppc64el](#), [s390x](#), [x86_64](#)
- Desktop: [GNOME](#), [Unity](#)
- Categoria: [Beginners](#), [Desktop](#), [Server](#), [Live Medium](#)
- Stato: [Attiva](#)
- Popolarità: [5 \(1,402 visite al giorno\)](#)



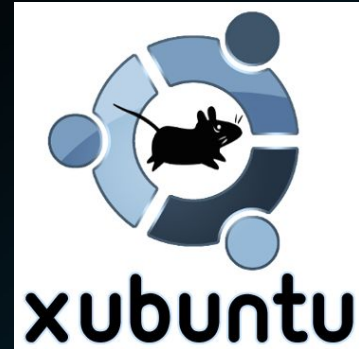



List of releases

[Ubuntu Website release cycle page](#)

Current

Version	Code name	Docs	Release	End of Standard Support	End of Life
Ubuntu 19.10	Eoan Ermine	Release Notes	October 17, 2019	July, 2020	July, 2020
Ubuntu 19.04	Disco Dingo	Release Notes	April 18, 2019	January, 2020	January, 2020
Ubuntu 18.04.3 LTS	Bionic Beaver	Changes	August 8, 2019	April 2023	April 2028
Ubuntu 18.04.2 LTS	Bionic Beaver	Changes	February 15, 2019	April 2023	April 2028
Ubuntu 18.04.1 LTS	Bionic Beaver	Changes	July 26, 2018	April 2023	April 2028
Ubuntu 18.04 LTS	Bionic Beaver	Release Notes	April 26, 2018	April 2023	April 2028
Ubuntu 16.04.6 LTS	Xenial Xerus	Changes	February 28, 2019	April 2021	April 2024
Ubuntu 16.04.5 LTS	Xenial Xerus	Changes	August 2, 2018	April 2021	April 2024
Ubuntu 16.04.4 LTS	Xenial Xerus	Changes	March 1, 2018	April 2021	April 2024
Ubuntu 16.04.3 LTS	Xenial Xerus	Changes	August 3, 2017	April 2021	April 2024
Ubuntu 16.04.2 LTS	Xenial Xerus	Changes	February 16, 2017	April 2021	April 2024
Ubuntu 16.04.1 LTS	Xenial Xerus	Changes	July 21, 2016	April 2021	April 2024
Ubuntu 16.04 LTS	Xenial Xerus	Release Notes	April 21, 2016	April 2021	April 2024
Ubuntu 14.04.6 LTS	Trusty Tahr	Changes	March 7, 2019	April 2019	April 2022
Ubuntu 14.04.5 LTS	Trusty Tahr	Changes	August 4, 2016	April 2019	April 2022
Ubuntu 14.04.4 LTS	Trusty Tahr	Changes	February 18, 2016	HWE August 2016	April 2022
Ubuntu 14.04.3 LTS	Trusty Tahr	Changes	August 6, 2015	HWE August 2016	April 2022
Ubuntu 14.04.2 LTS	Trusty Tahr	Changes	February 20, 2015	HWE August 2016	April 2022
Ubuntu 14.04.1 LTS	Trusty Tahr	Changes	July 24, 2014	April 2019	April 2022
Ubuntu 14.04 LTS	Trusty Tahr	Release Notes	April 17, 2014	April 2019	April 2022

Release announcements are posted on the [ubuntu-announce mailing list](#).



PRO

- ◆ Ogni release ogni 6 mesi
- ◆ Versione LTS
- ◆ Partner Canonical
- ◆ User-friendly, tutto pronto per un utente "beginner"
- ◆ È una delle distro più usate

CANONICAL

CONTRO

- ◆ Poca stabilità
- ◆ Più pesante rispetto ad altre distro



In Africa there is a concept known as '**ubuntu**' - the profound sense that we are human only through the humanity of others

~ Nelson Mandela



Linux Mint
from freedom came elegance



Computer



Home



In



Linux Mint

- **Tipo:** [Linux](#)
- **Basata su:** [Debian](#), [Ubuntu \(LTS\)](#)
- **Provenienza:** [Ireland](#)
- **Architetture:** [i386](#), [x86_64](#)
- **Desktop:** [Cinnamon](#), [MATE](#), [Xfce](#)
- **Categoria:** [Beginners](#), [Desktop](#), [Live Medium](#)
- **Stato:** **Attiva**
- **Popolarità:** [3 \(2,043 visite al giorno\)](#)



Sound & Video

Backup Tool

Universal Access

Bluetooth

Administration

Calculator

Preferences

Calendar

Places

Character Map

Color

Date & Time





PRO

- ❏ Favorisce la diffusione delle tecnologie open source, ma considera anche alternative del mondo proprietario, e l'esperienza dell'utente viene prima dei problemi di licenza
- ❏ È user-friendly, mira ad avere un'esperienza più intuitiva per l'utente
- ❏ Gestisce gli aggiornamenti diversamente da Ubuntu per conferire una maggiore stabilità all'OS.
- ❏ È una delle distro più usate

CONTRO

- ❏ Poca stabilità rispetto a Debian (ma non rispetto ad Ubuntu)
- ❏ Più pesante rispetto ad altre distro
- ❏ Non comunica le date di pubblicazione delle nuove distribuzioni, ma le versioni sono annunciate "quando pronte" (when ready)
- ❏ Open source & software proprietario

<https://community.linuxmint.com/idea/welcome>



\$ whoami

- Stefano Borzì
- @Helias
- github.com/Helias

GRAZIE DELL'ATTENZIONE